

FICHE PRODUIT / PRODUCT SHEET

— HOLLO —

Tabouret – Tables / Stool – Tables

AC/AL STUDIO

PETITE FRITURE

01/2018

AC/AL STUDIO
FRANÇAIS / FRENCH - 2012



Diplômés d'ENSCI-Les Ateliers, Amandine Chhor et Aïssa Logerot ont commencé leur carrière en travaillant cinq ans pour des agences d'architecture et de design, et des entreprises comme Hermès. De 2009 à 2012, ils ont collaboré à des projets de design contemporain utilisant des techniques artisanales durables dans des pays en développement comme le Cambodge, le Maroc et le Cameroun. Le duo a fondé son propre studio de design à Paris en 2013 avec l'objectif de créer des objets qui ont une histoire à raconter et à cultiver un équilibre parfait entre la fonction, la forme et les techniques de production. Passionnés pour les matériaux, l'artisanat et les procédés de fabrication industrielle, ils dessinent des produits et des meubles qui valorisent l'utilité et la rigueur de la simplicité.

« Les objets que nous créons reflètent l'intérêt que nous avons pour les matériaux et les techniques de fabrication, qu'elles soient artisanales ou industrielles. Complémentaires dans notre travail et partageant une même vision du design, nous avons travaillé sur une gamme de mobiliers pour Petite Friture, initialement pensée pour l'artisanat, que nous avons ensuite adaptée afin de la produire en série. » AC/AL STUDIO

After graduating from ENSCI-Les Ateliers, Amandine Chhor and Aïssa Logerot kick-started their careers working in architecture and design studios for five years, as well as for companies such as Hermès. Between 2009 and 2012, they collaborated on contemporary design projects, using sustainable artisanal techniques, in developing countries such as Cambodia, Morocco and Cameroon. The duo founded their own design studio in Paris in 2013, with the aim of creating objects that tell a story and achieve a perfect balance between function, form and production technique. Passionate about materials, arts and crafts, and industrial manufacturing processes, they design products and furniture that are functional yet simplistic.

« The objects we create reflect the interest we have in materials and manufacturing techniques, whether craft or industrial. As we are complementary in our work and share the same idea on design, we have worked on a range of tables for Petite Friture, initially thought for crafts, and today re-adapted to be produced in series. » AC/AL STUDIO

Autres produits / Other products :



TRAME
CHAISES / CHAIRS



DOJO
TABLE, CHAISE, BRIDGE /
TABLE, CHAIR, BRIDGE

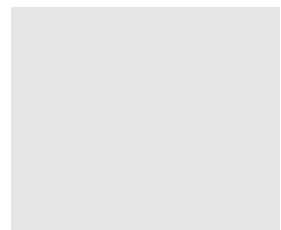
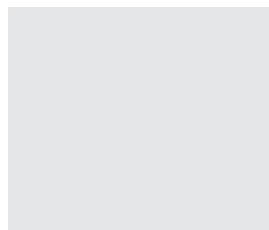

HOLLO
TABOURETS – TABLES / STOOLS – TABLES
AC/AL STUDIO

Creation 2012
Edition 2012



HOLLO...

Amandine Chhor et Aïssa Logerot ont utilisé de la bande d'acier pour développer une série de tables aux lignes rythmiques. Avec leur allure simple et solide, et par ailleurs leur stabilité et leur revêtement époxy, les tables HOLLO s'adaptent à un usage intérieur comme extérieur.

VU PAR SON DESIGNER :

« La gamme HOLLO joue avec les vides, les lignes rythmiques et les surfaces pleines ; elle saisit notre regard et le laisse s'échapper. Simple et mono-matériau, elle utilise les codes industriels et s'efface derrière l'usage et la fonction. »
AMANDINE CHHOR & AÏSSA LOGEROT

Amandine Chhor and Aïssa Logerot used a band of steel to develop a series of tables in rhythmic lines. Their simple and solid allure, combined with their stability and epoxy coating mean that the HOLLO tables can be used both indoors and out.

ACCORDING TO ITS DESIGNER:

« The HOLLO range plays with gaps, rhythmical lines and full surfaces : they alternatively catch our eye, and let it go. Simple, with only one material, these tables use industrial codes and give priority to usage and function. »
AMANDINE CHHOR & AÏSSA LOGEROT

INFORMATIONS PRODUITS
PRODUCTS INFORMATIONS

TABLE D'APPOINT - TABOURET / SIDE TABLE - STOOL (ANTHRACITE / ANTHRACITE)

Reference : **M0140402**





EAN : **3760236181276**

Materials	Colours		Product	Ø	H	Packaging	L	W	H
Acier, peinture epoxy grainée	Anthracite		cm	35	44	cm	41.5	41	52
Steel, grained epoxy paint	Anthracite		inch	13.8	17.3	inch	16.3	16.1	20.5

W: 4 kg / 8.8 lb **W: 5.6 kg / 12.3 lb**

TABLE D'APPOINT - TABOURET / SIDE TABLE - STOOL (OR / GOLD)

Reference : **M0140405**

EAN : **3760236181269**

Materials	Colours		Product	Ø	H	Packaging	L	W	H
Acier, peinture epoxy grainée	Or		cm	35	44	cm	41.5	41	52
Steel, grained epoxy paint	Gold		inch	13.8	17.3	inch	16.3	16.1	20.5

W: 4 kg / 8.8 lb **W: 5.6 kg / 12.3 lb**

INFORMATIONS PRODUITS
PRODUCTS INFORMATIONS

TABLE D'APPOINT - TABOURET / SIDE TABLE - STOOL (NOIR / BLACK)

Reference : M0140407



EAN : 3760236183416

Materials	Colours	
Acier, peinture epoxy grainée	Noir	
Steel, grained epoxy paint	Black	

Product	Ø	H
cm	35	44
inch	13.8	17.3

W: 4 kg / 8.8 lb

Packaging	L	W	H
cm	41.5	41	52
inch	16.3	16.1	20.5

W: 5.6 kg / 12.3 lb

TABLE D'APPOINT - TABOURET / SIDE TABLE - STOOL (BLANC / WHITE)

Reference : M0140408



EAN : 3760236184802

Materials	Colours	
Acier, peinture epoxy grainée	Blanc	
Steel, grained epoxy paint	White	

Product	Ø	H
cm	35	44
inch	13.8	17.3

W: 4 kg / 8.8 lb

Packaging	L	W	H
cm	41.5	41	52
inch	16.3	16.1	20.5

W: 5.6 kg / 12.3 lb

INFORMATIONS PRODUITS
PRODUCTS INFORMATIONS

TABLE D'APPOINT - TABOURET / SIDE TABLE - STOOL (BORDEAUX / BURGUNDY)

Reference : M0140409



EAN : 3760236185472

Materials	Colours		Product	Ø	H	Packaging	L	W	H	
Acier, peinture epoxy grainée	Bordeaux		cm		35	44	cm	41.5	41	52
Steel, grained epoxy paint	Burgundy		inch		13.8	17.3	inch	16.3	16.1	20.5

W: 4 kg / 8.8 lb W: 5.6 kg / 12.3 lb

TABLE D'APPOINT - TABOURET / SIDE TABLE - STOOL (BLEU / BLUE)

Reference : M0140410



EAN : 3760236185489

Materials	Colours		Product	Ø	H	Packaging	L	W	H	
Acier, peinture epoxy grainée	Bleu		cm		35	44	cm	41.5	41	52
Steel, grained epoxy paint	Blue		inch		13.8	17.3	inch	16.3	16.1	20.5

W: 4 kg / 8.8 lb W: 5.6 kg / 12.3 lb

INFORMATIONS PRODUITS
PRODUCTS INFORMATIONS

TABLE BASSE / COFFEE TABLE (ANTHRACITE / ANTHRACITE)

Reference : M0140502

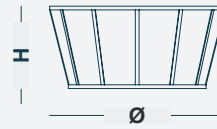

EAN : 3760236181290

Materials	Colours	
Acier, peinture epoxy grainée	Anthracite	
Steel, grained epoxy paint	Anthracite	

Product	Ø	H
cm	70	33
inch	27.6	13

W: 12 kg / 2.2 lb

Packaging	L	W	H
cm	76	74.5	40
inch	29.9	29.3	15.8

W: 15.3 kg / 33.7 lb

TABLE BASSE / COFFEE TABLE (OR / GOLD)

Reference : M0140505

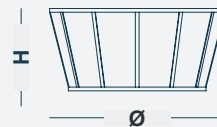

EAN : 3760236181283

Materials	Colours	
Acier, peinture epoxy grainée	Or	
Steel, grained epoxy paint	Gold	

Product	Ø	H
cm	70	33
inch	27.6	13

W: 12 kg / 2.2 lb

Packaging	L	W	H
cm	76	74.5	40
inch	29.9	29.3	15.8

W: 15.3 kg / 33.7 lb

INFORMATIONS PRODUITS
PRODUCTS INFORMATIONS

TABLE BASSE / COFFEE TABLE (NOIR / BLACK)

Reference : M0140507

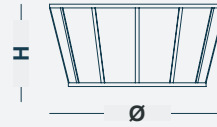

EAN : 3760236183423

Materials	Colours	
Acier, peinture epoxy grainée	Noir	
Steel, grained epoxy paint	Black	

Product	Ø	H
cm	70	33
inch	27.6	13

W: 12 kg / 2.2 lb

Packaging	L	W	H
cm	76	74.5	40
inch	29.9	29.3	15.8

W: 15.3 kg / 33.7 lb

TABLE BASSE / COFFEE TABLE (BLANC / WHITE)

Reference : M0140508



EAN : 3760236184789

Materials	Colours	
Acier, peinture epoxy grainée	Blanc	
Steel, grained epoxy paint	White	

Product	Ø	H
cm	70	33
inch	27.6	13

W: 12 kg / 2.2 lb

Packaging	L	W	H
cm	76	74.5	40
inch	29.9	29.3	15.8

W: 15.3 kg / 33.7 lb

INFORMATIONS PRODUITS
PRODUCTS INFORMATIONS

TABLE BASSE / COFFEE TABLE (BORDEAUX / BURGUNDY)

Reference : M0140509

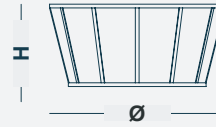

EAN : 3760236185496

Materials	Colours	
Acier, peinture epoxy grainée	Bordeaux	
Steel, grained epoxy paint	Burgundy	

Product	Ø	H
cm	70	33
inch	27.6	13

W: 12 kg / 2.2 lb

Packaging	L	W	H
cm	76	74.5	40
inch	29.9	29.3	15.8

W: 15.3 kg / 33.7 lb

TABLE BASSE / COFFEE TABLE (BLEU / BLUE)

Reference : M0140510



EAN : 3760236185502

Materials	Colours	
Acier, peinture epoxy grainée	Bleu	
Steel, grained epoxy paint	Blue	

Product	Ø	H
cm	70	33
inch	27.6	13

W: 12 kg / 2.2 lb

Packaging	L	W	H
cm	76	74.5	40
inch	29.9	29.3	15.8

W: 15.3 kg / 33.7 lb

INFORMATIONS PRODUITS
PRODUCTS INFORMATIONS

TABLE BISTROT / TABLE FOR TWO (ANTHRACITE / ANTHRACITE)



Reference : **M0140602**

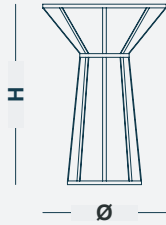

EAN : **3760236181313**

Materials	Colours		Product	Ø	H	Packaging	L	W	H
Acier, peinture epoxy grainée	Anthracite		cm	50	72	cm	56	56	78
Steel, grained epoxy paint	Anthracite		inch	28.4	19.7	inch	22.1	22.1	30.7

W: 7 kg / 15.4 lb **W: 11.1 kg / 24.5 lb**

TABLE BISTROT / TABLE FOR TWO (OR / GOLD)



Reference : **M0140605**

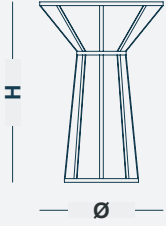

EAN : **3760236181306**

Materials	Colours		Product	Ø	H	Packaging	L	W	H
Acier, peinture epoxy grainée	Or		cm	50	72	cm	56	56	78
Steel, grained epoxy paint	Gold		inch	28.4	19.7	inch	22.1	22.1	30.7

W: 7 kg / 15.4 lb **W: 11.1 kg / 24.5 lb**

INFORMATIONS PRODUITS
PRODUCTS INFORMATIONS

TABLE BISTROT / TABLE FOR TWO (NOIR / BLACK)

Reference : M0140607

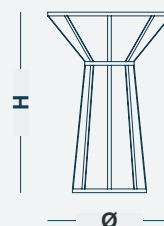

EAN : 3760236183430

Materials	Colours
Acier, peinture epoxy grainée	Noir
Steel, grained epoxy paint	Black



Product	Ø	H
cm	50	72
inch	28.4	19.7

W: 7 kg / 15.4 lb

Packaging	L	W	H
cm	56	56	78
inch	22.1	22.1	30.7

W: 11.1 kg / 24.5 lb

TABLE BISTROT / TABLE FOR TWO (BLANC / WHITE)

Reference : M0140608

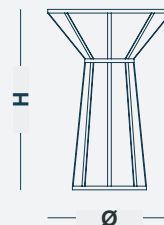

EAN : 3760236184796

Materials	Colours
Acier, peinture epoxy grainée	Blanc
Steel, grained epoxy paint	White



Product	Ø	H
cm	50	72
inch	28.4	19.7

W: 7 kg / 15.4 lb

Packaging	L	W	H
cm	56	56	78
inch	22.1	22.1	30.7

W: 11.1 kg / 24.5 lb

INFORMATIONS PRODUITS
PRODUCTS INFORMATIONS

TABLE BISTROT / TABLE FOR TWO (BORDEAUX / BURGUNDY)

Reference : M0140609

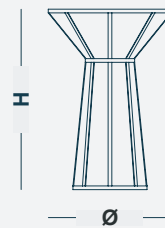

EAN : 3760236185519

Materials	Colours	
Acier, peinture epoxy grainée	Bordeaux	
Steel, grained epoxy paint	Burgundy	

Product	Ø	H
cm	50	72
inch	28.4	19.7

W: 7 kg / 15.4 lb

Packaging	L	W	H
cm	56	56	78
inch	22.1	22.1	30.7

W: 11.1 kg / 24.5 lb

TABLE BISTROT / TABLE FOR TWO (BLEU / BLUE)

Reference : M0140610

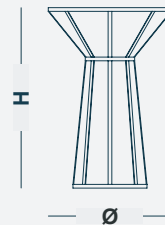

EAN : 3760236185526

Materials	Colours	
Acier, peinture epoxy grainée	Bleu	
Steel, grained epoxy paint	Blue	

Product	Ø	H
cm	50	72
inch	28.4	19.7

W: 7 kg / 15.4 lb

Packaging	L	W	H
cm	56	56	78
inch	22.1	22.1	30.7

W: 11.1 kg / 24.5 lb

SPÉCIFICATIONS TECHNIQUES
TECHNICAL SPECIFICATIONS

• Environnement :
intérieur et extérieur /

Environment :
indoor and outdoor

• Fabriqué en Europe
(Pologne) /
Made in Europe
(Poland)

OPTIONS SUR-MESURE
CUSTOM OPTIONS

ECHANTILLONS DISPONIBLES SUR DEMANDE /
SAMPLES AVAILABLE ON REQUEST

POUR TOUTES INFORMATIONS COMPLÉMENTAIRES OU AUTRES DEMANDES,
N'HÉSITEZ PAS À NOUS CONTACTER.

FOR ANY REQUEST OR FUTHER INFORMATION, PLEASE CONTACT US.

CONTACT

PETITE FRITURE

Showroom

83 boulevard Richard Lenoir, 75011 - Paris

T +33 (0)1 44 54 13 95

F +33 (0)1 44 54 02 19

petitefriture.com

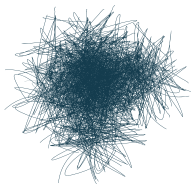

**PETITE
FRITURE**
ÉDITEUR DE DESIGN