



BuzziPleat

Product Specification Sheet

This document contains technical information about the BuzziPleat





www.buzzi.space

A series of architectural solutions by 13&9 Design

The BuzziPleat reinterprets ancient techniques used in fashion design, like smocking and pleating, to create large-scale, yet lightweight sculptural forms, made of sound-absorbing BuzziFelt. Architectural folds maximize surface area, delivering exceptional acoustic performance.

Design by 13&9 Design

General

-  BuzziPleat Edel | BuzziPleat Ripple
Fixing: Wall | Suspended
-  BuzziFelt Pleat
OffWhite or Black lace
Metal support black
-  Fixation: wall mounted | ceiling suspended
Black or Alu cables 2 - 5 m | 78.74" - 196.85"
Optional extra layer BuzziFabric

Acoustics



Absorption



Diffusion

Content

Configurations	3	Fixing Systems	6
Fabrics	5	Dimensions	7
Finishes	5	Acoustics	8

Configurations

BuzziPleat Ripple Suspended

◆ M, L

BuzziFelt Pleat

🌲 OffWhite or Black lace
Metal Support Black

M: Ø 100 cm H 13 cm
Ø 39.37" H 5.21"

✂ L: Ø 150 cm H 19,5 cm
Ø 59.06" H 7.68"

⚖ M: 5,2 kg | 11.46 lbs
L: 10,9 kg | 24.03 lbs

Lace: OffWhite or Black

⋮ Optional extra layer BuzziFabric (only in combination with OffWhite or Anthracite Felt)
Black or Alu cables 2 - 5 m | 78.74" - 196.85"

⚠ If installing on suspended ceiling, verify load capacity prior to installation.

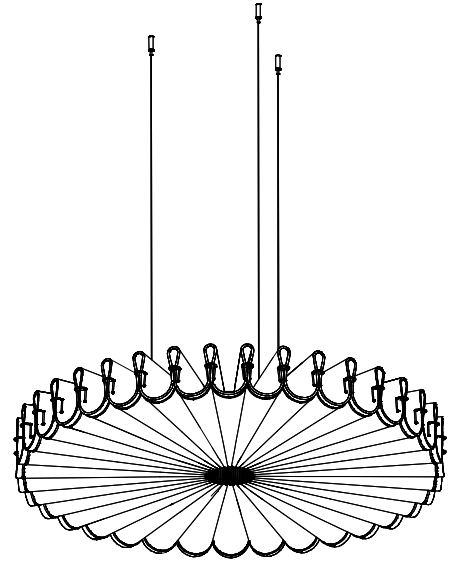

BuzziPleat Ripple Wall Mounted

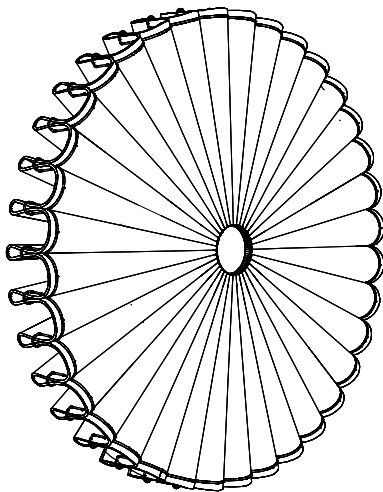

◆ M, L

BuzziFelt Pleat

OffWhite or Black Lace

🌲 Metal support black
Central wooden support in Ash White Wash or Ash Black Stained

M: Ø 100 cm H 13 cm
Ø 39.37" H 5.31"

✂ L: Ø 150 cm H 19,5 cm
Ø 59.06" H 3.54"

⚖ M: 5,7 kg | 12.57 lbs
L: 11,4 kg | 25.13 lbs

Lace: OffWhite or Black

⋮ Optional extra layer BuzziFabric (only in combination with OffWhite or Anthracite Felt)

BuzziPleat Edel Suspended

◆ M, L

BuzziFelt Pleat

🌲 OffWhite or Black lace
Metal support black

M: Ø 100 cm H 9 cm
Ø 39.37" H 3.54"

✂ L: Ø 150 cm H 13,5 cm
Ø 59.06" H 5.31"

⚖ M: 4,2 kg | 9.26 lbs
L: 8,9 kg | 17.62 lbs

Lace: OffWhite or Black

⋮ Optional extra layer BuzziFabric (only in combination with OffWhite or Anthracite Felt)
Black or Alu cables 2 - 5 m | 78.74" - 196.85"

⚠ If installing on suspended ceiling, verify load capacity prior to installation.

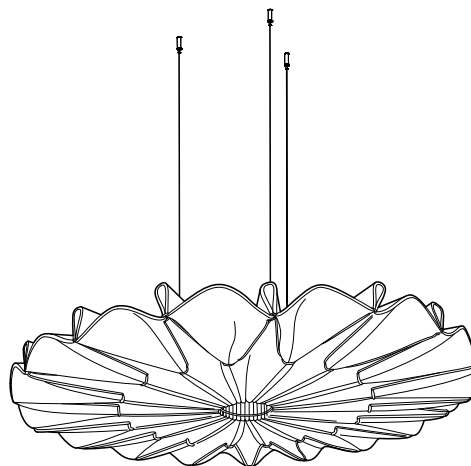

BuzziPleat Edel Wall Mounted

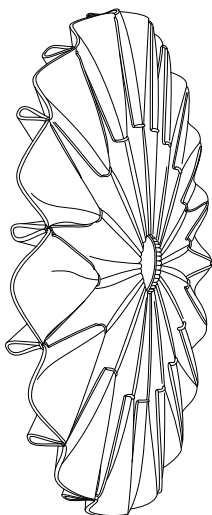

◆ M, L

BuzziFelt Pleat

🌲 OffWhite or Black lace
Metal support black
Central Wooden Support in Ash White Wash or Ash Black Stained

M: Ø 100 cm H 9 cm
Ø 39.37" H 3.54"

✂ L: Ø 150 cm H 13.5 cm
Ø 59.06" H 5.31"

⚖ M: 4,7 kg | 10.36 lbs
L: 9,4 kg | 20.72 lbs

Lace: OffWhite or Black

⋮ Optional extra layer BuzziFabric (only in combination with OffWhite or Anthracite Felt)

Fabrics

Felt

Composition 100% Recycled P.E.T. Felt, latex backing
Weight 1.000 g/m² | 29.49 oz/yd²
Abrasion resistance >7.000 Martindale
Flammability EU: EN 13501.1 + A1/2009 Class B-s1,d0
USA: ASTM E84 Class A certified
Fastness to light USA 5



FE-OffWhite 63*

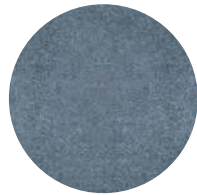

FE-StoneGrey 67

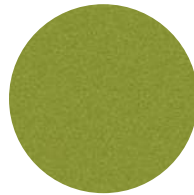

FE-Lime 64

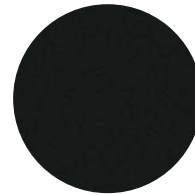

FE-Anthracite 68*

*Extra layer BuzziFabric Possible

Fabric

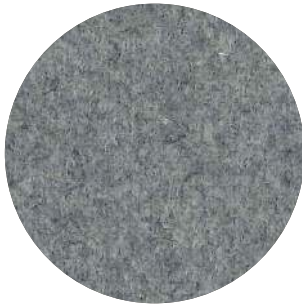

Category A
Composition 70% Recycled Wool, 25% Recycled Polyacryl,
5% Recycled Other Fabrics
Weight 405 g/m² | 11.94 oz/yd²
Abrasion resistance 40.000 Martindale, 50,000 Wyzenbeek
Flammability EU: EN 1021.1/2006 | BS EN 1021.1/2006 (cigarette).
EN 1021.2/2006 | BS EN 1021.2/2006 (match)
USA: CAL TB 117 | ASTM E84 CLASS A
Fastness to light EU: 4 | USA 4
Fastness to rubbing EU: Wet 3-4 | Dry 4-5
Fastness to crocking USA: Wet 5 | Dry 5



Finishes

Wood



Ash Black Stained



Ash White Wash

Fixing Systems

Fixing System Ceiling Suspended

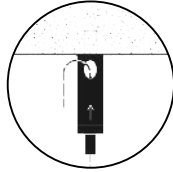
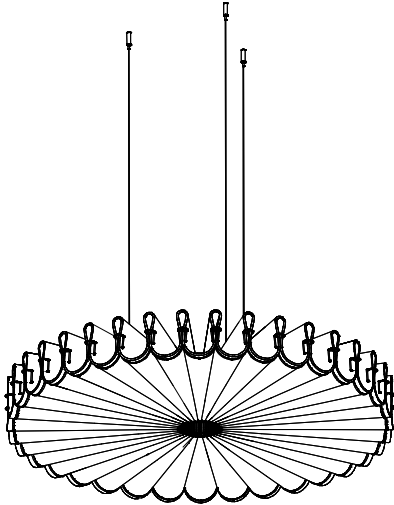

Fixing System Screw

- Black metal support
- 3 cables of 2 - 5 m | 78.74" - 196.85"
- Black or aluminium colored cables

Formations, as with other architectural features located in the ceiling plane, may obstruct or skew the existing or planned fire sprinkler water distribution pattern, or possibly delay the activation of the fire sprinkler or fire detection system. Designers and installers are advised to consult a protection engineer, NFPA 13, and their local codes for guidance on the proper installation techniques where detection or suppression systems are present.

Fixing System Wall

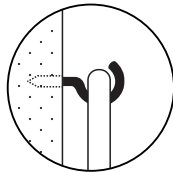
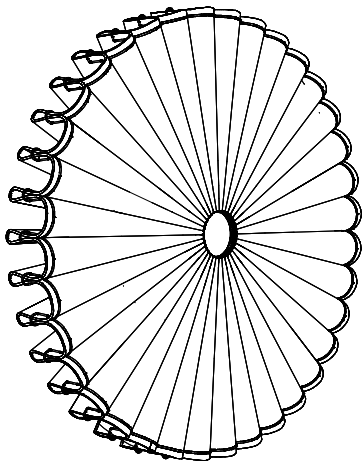

Fixing System Wall

- Black metal support
- Wooden center in Ash Black Stained in combination with Black lace or Ash White Wash in combination with an OffWhite lace
- Excl. mounting hook

Dimensions

BuzziPleat Ripple

M Ø 100 cm | 39.37"
L Ø 150 cm | 59.06"
d Ø 10 ~ 12 cm | 3.94" ~ 4.72"

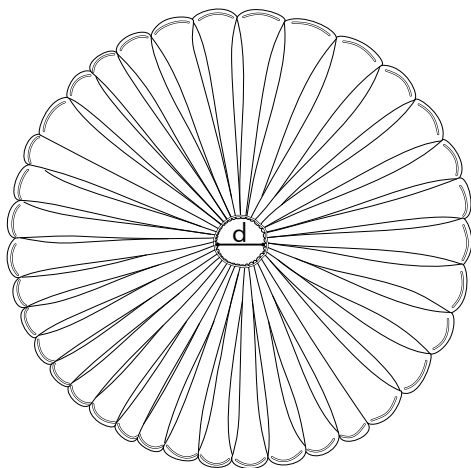

M 13 cm | 5.21"
L 19,5 cm | 7.68"

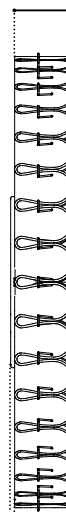

1 cm | 0.39"

BuzziPleat Edel

M Ø 100 cm | 39.37"
L Ø 150 cm | 59.06"
d Ø 10 ~ 12 cm | 3.94" ~ 4.72"

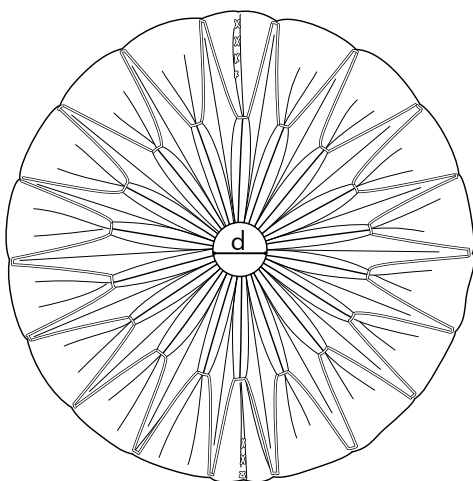

M 9 cm | 3.54"
L 13,5 cm | 5.31"



1 cm | 0.39"

Acoustics

BuzziPleat Ripple M

Equivalent sound absorption area in m² per object

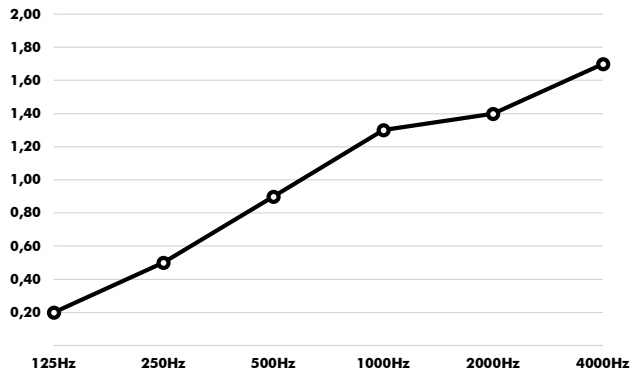

Hz	M
125	0.2
250	0.5
500	0.9
1000	1.3
2000	1.4
4000	1.7